

KTR-02
KTR-03

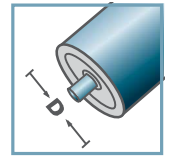

D [mm]
50

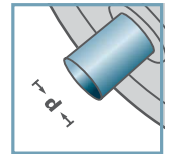

d [mm]
8; 10



C [daN]
15

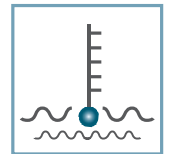

T [°C]
0° - 80°



-



Karton [Stck.]

50x1,5: 250
50x2,0: 250
50x2,8: 250

KTR-02/03					
Typ	Normal .02	Niro .03	Di +0,2	Da	Tragzahl C [daN]
KTR-50x1,5	x	x	47,3	49,9	15
KTR-50x2,0	x	x	46,3	49,9	15
KTR-50x2,8	x	x	44,6	49,9	15

Weitere Varianten auf Anfrage!

- ☛ Radkörper: Kunststoff
- ☛ Nabe: Kunststoff
- ☛ Lagerdeckel: Kunststoff
- ☛ Käfig: Kunststoff
- ☛ Kugel
 - ☛ 02: Stahl
 - ☛ 03: 1.4034



KTR

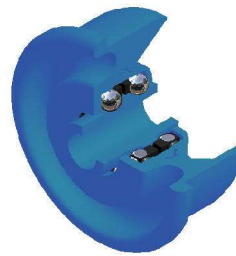
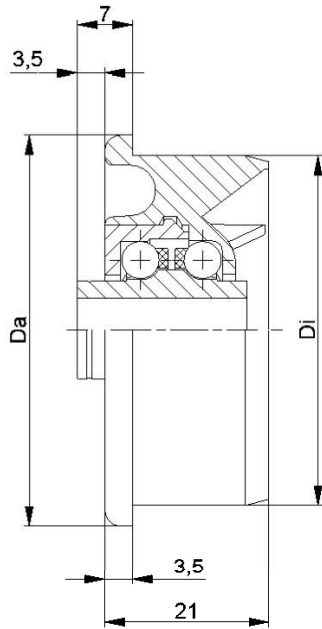

KTR-02
KTR-03

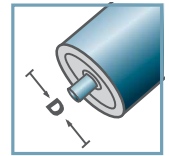

D [mm]
50

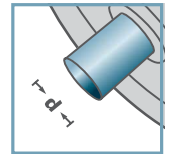

d [mm]
12; SW11

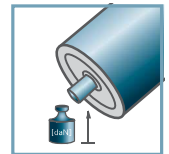

C [daN]
10

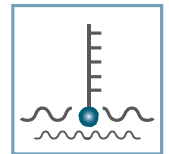

T [°C]
0° - 80°



Karton [Stck.]

250

KTR-02/03

Typ	Normal .02	Niro .03	Di +0,2	Da	Tragzahl C [daN]
KTR-50x1,5	x	x	47,3	49,9	10
KTR-50x2,8	x	x	44,6	49,9	10

Weitere Varianten auf Anfrage!

- Radkörper: Kunststoff
- Nabe: Kunststoff
- Lagerdeckel: Kunststoff
- Käfig: Kunststoff
- Kugel
 - 02: Stahl
 - 03: 1.4034



KTR